

1/7 Scale 4WD ELECTRIC DESERT BUGGY

Manual

www.zdhobby.com

DBX-07



www.zdhobby.com

ZD RACING

www.zdhobby.com



Made in china



This manual expatiates the structure of the model. In order to better maintain and replace the spare parts, please keep and take it for reference. The user who is not familiar with the assembling, please contact with the wholesaler, nominated model shops and the Special after-sale service outlets.

The actual version is subject to the real standard. It would be varied because of different versions.

The spare parts, appearance of this model will be tiny revised and changed before totally upgrade into a new version, ZD reserve this rights, and no further notice.

ZD RACING

INTRODUCE

Thank you for choosing the ZD racing series products. Our company take the target of offering the top quality and best service. Through attending the competitions and repeated testing the products, constantly enhancing our experience, then further improving the design and quality control. Only for showing the great performance products. This manual including all the important matter before operating the car. We advise studying and knowing the control system before assembling or playing it. As well as the further upgrade and maintenance. Please feel free to consult our authorized dealer, nominated model shop or special after-sale service station if any question refer to the play or use. Our website is: www.zdhobby.com. We are wholeheartedly for your service.

QUALITY ASSURANCE

Our company take the fully responsibility to the quality defect during the manufacturing process. This assurance is only subject to the product only and its spare parts.

These situation below are not included:

- The breakage caused by using, assembling or adjustment.
- The other breakage not related to the quality itself.

IMPORTANT STATEMENT

The Model Car is not a toy. It is the casual item combine a lot of high technology products. If using improper may bring serious damage. Please read the manual detailed before using, and keep yourself safe.

Attention: Any operation of the Model car, the manufacturer and dealers are incapable of take the responsibility of the accidents caused by wear out or abnormal assemble.

This product is provided to those who have operation remote control model car experience or a technical personnel in the guidance of the local legal field, in has to ensure the safe and correct operation under the condition of use. Our company will not accept any operation and use the control on any performance and safety responsibility

The RC products are belong to consumable goods, if disassemble, it may cause the spare parts loss, Any use of goods caused by bad or not satisfied, will not be able to replace or return, such as in case of operation maintenance problems, the company designated national distributor model shop and special after-sale service store will provide technical guidance, and special parts supply services.



Warning: because of the neglect of these operating instructions, and use wrongly may cause property damage or serious injury.

Note: because of the neglect of these operating instructions, and use wrongly could be dangerous.

Ban: in any prohibited environment, do not try to operation.

SAFETY GUIDELINES

1. Don't operation the models close to open fires or near heat source.
2. Operation must be in the open and dry site .
3. The thunderstorm weather is forbidden to operate this product.
4. Away from the high voltage cables.
5. Some of the parts will be exothermic or burning after operated.
6. Please do not use hand or foreign body contact activities of the parts before cut off the power supply,

7. During the operation, if foreign matter or liquid get into eyes, please timely with plenty of water flush eyes, and immediately consulting professional doctor. As the body is injured, please seek immediate medical attention.
8. Keep out of the reach of children, this is not toy, strongly suggest adult supervision.
9. Placed in ventilated and dry place, do not use, take the battery out.
10. The product items do not diet or swallowed.

2.4G RC WITH 4-CHANNELS SETUP AND FAIL SAFE FUNCTION

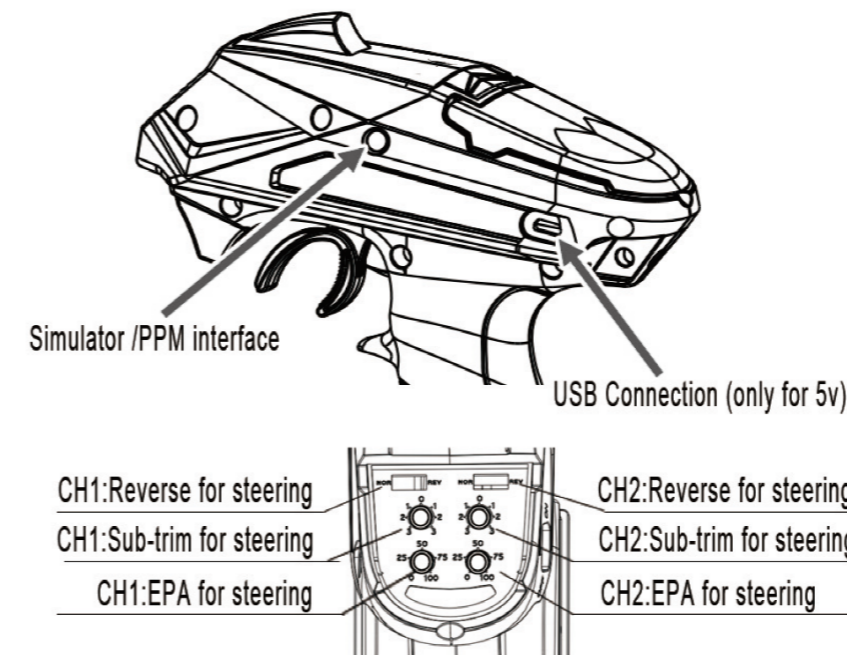
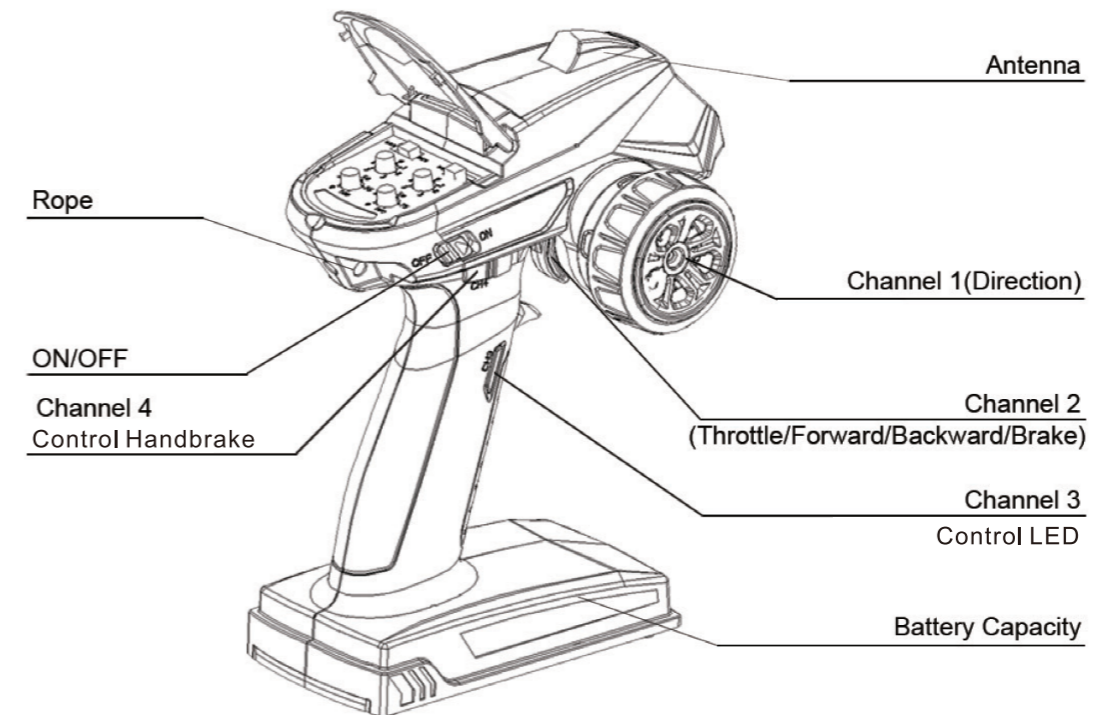

Receiver

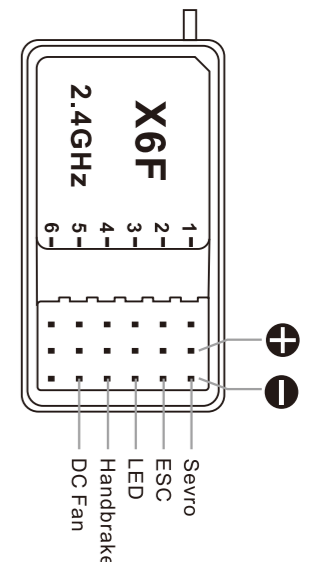

CHARGING THE BATTERY PACK

- Once the battery ready to be charged, first plug the AC quick charger into the outlet of AC power source, and then connect the battery input/output harness to the charger.
- Continued to monitor the battery as it is being charged. As soon as the battery is fully charged, disconnect the battery from the charger plug (Over-charging or charging incorrectly using inadequate chargers may cause the battery pack to become dangerously hot).
- For best results, let the battery pack cool before charging. Heat may prevent the battery pack from charging to full capacity and also decreases the performance of the battery.

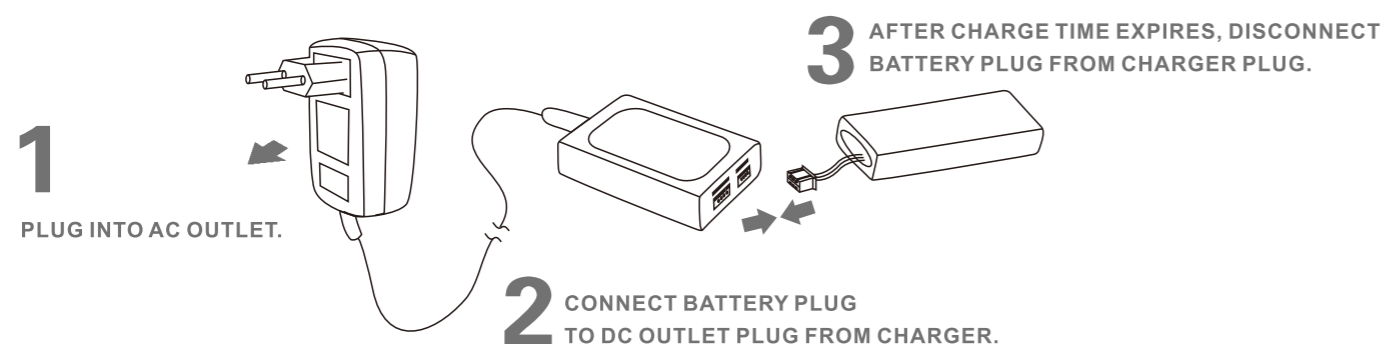

BATTERIES

Lithium Polymer (Li-Po) batteries are becoming popular for use in R/C models due to their compact size, high energy density, and high-current output. However, these types of batteries require special care and handling procedures for long life and safe operation.

Warning: Lithium Polymer (Li-Po) batteries are intended only for advanced users that are educated on the risks associated with Li-Po battery use. THUNDER TIGER/ACE RC does not recommend that anyone under the age of 16 use or handle Li-Po battery packs without the supervision of a knowledgeable and responsible adult.

- Important:**
- Do not use NiCd/Ni-MH battery chargers for Li-PO batteries. If you do not use a special charger for Li-PO battery, they will be damaged.
 - If the battery is swollen or damaged, it is forbidden to use.
 - Do not charge for long periods when left unattended.

Please note! Consumers for use or installation of lipo battery in the remote control model belongs and cause any Direct or indirect damages, our company will not bear any legal liability.

Steering operation guide

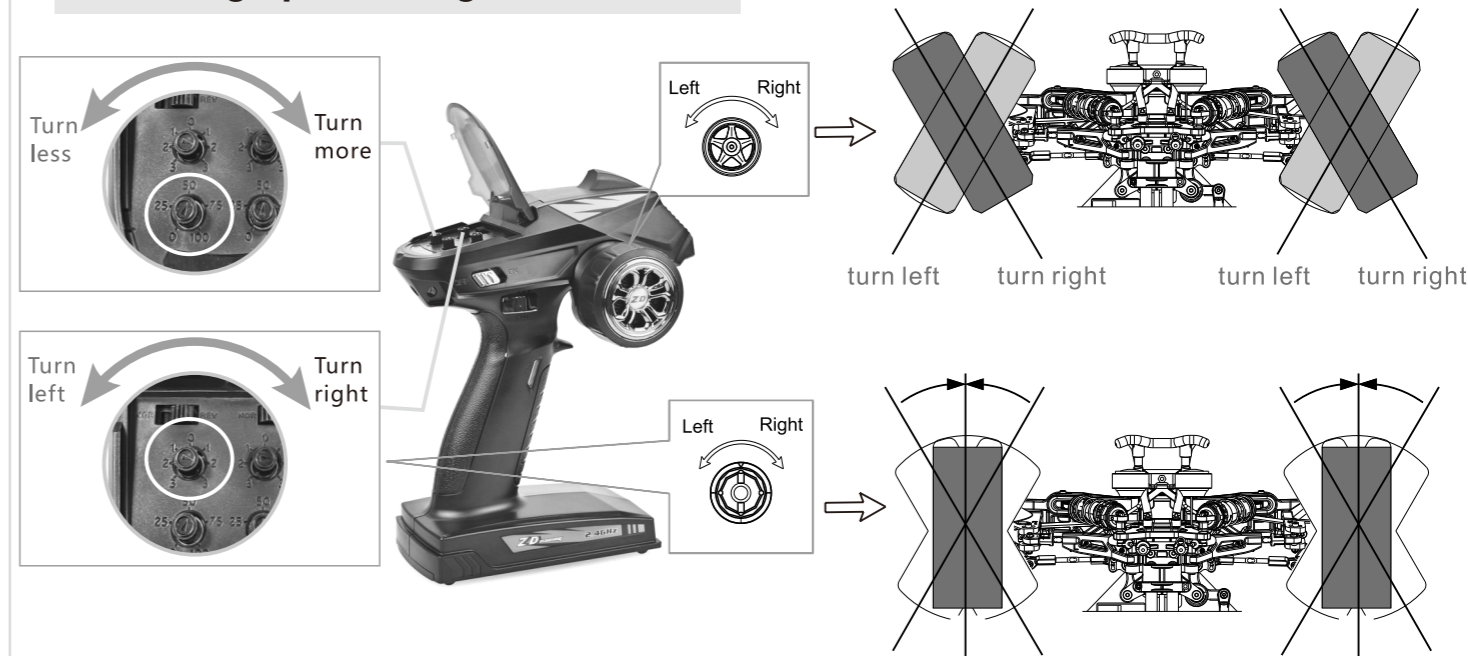

- slowly rotating around the steering wheel, the car will be slow to the right or to the left accordingly (when there is no consistent please toggle on the remote control ST direction and rudder switch).
- when the cars can't run straight, you can adjust te direction of the remote control on the median knob, until the vehicle can run straight.

- ◆ Adjust the Median trimming to keep the front wheel in the center position
- ◆ When testing the diversion of the car, please keep the front wheel hang in the air.

Racing Steps

- Turn on the remote control switch, the power indicator flashes.
- Turn the steering wheel and throttle trigger, everything is normal, you can go running.
- Finish racing, Turn off the ESC and off the radio, disconnect the power plug.

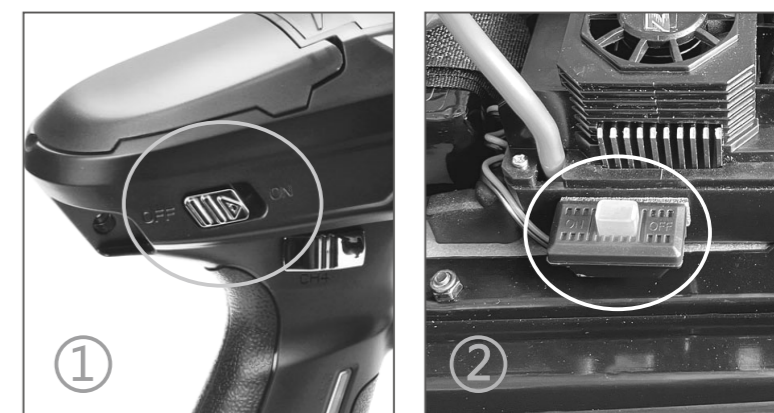

1

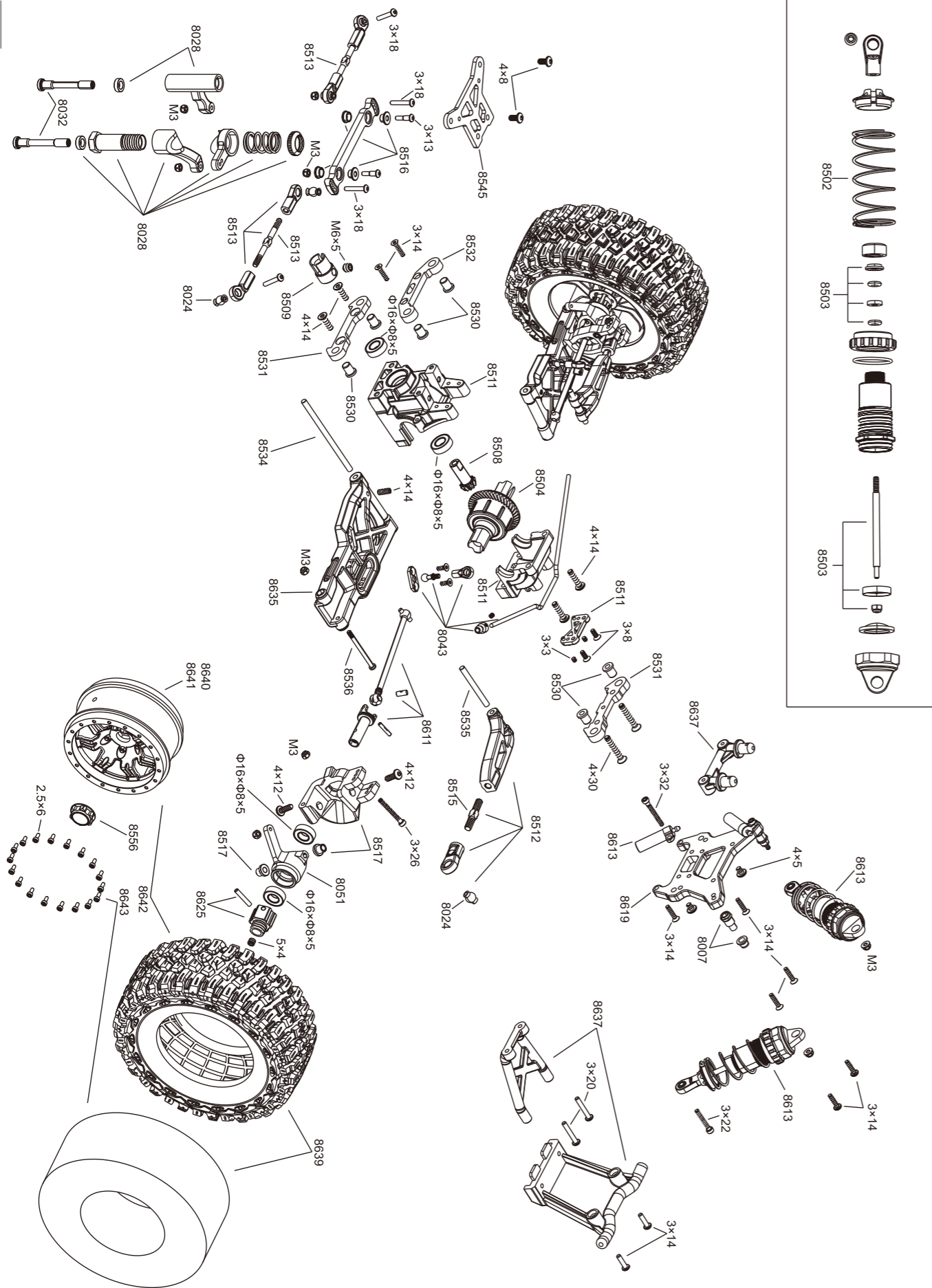

2

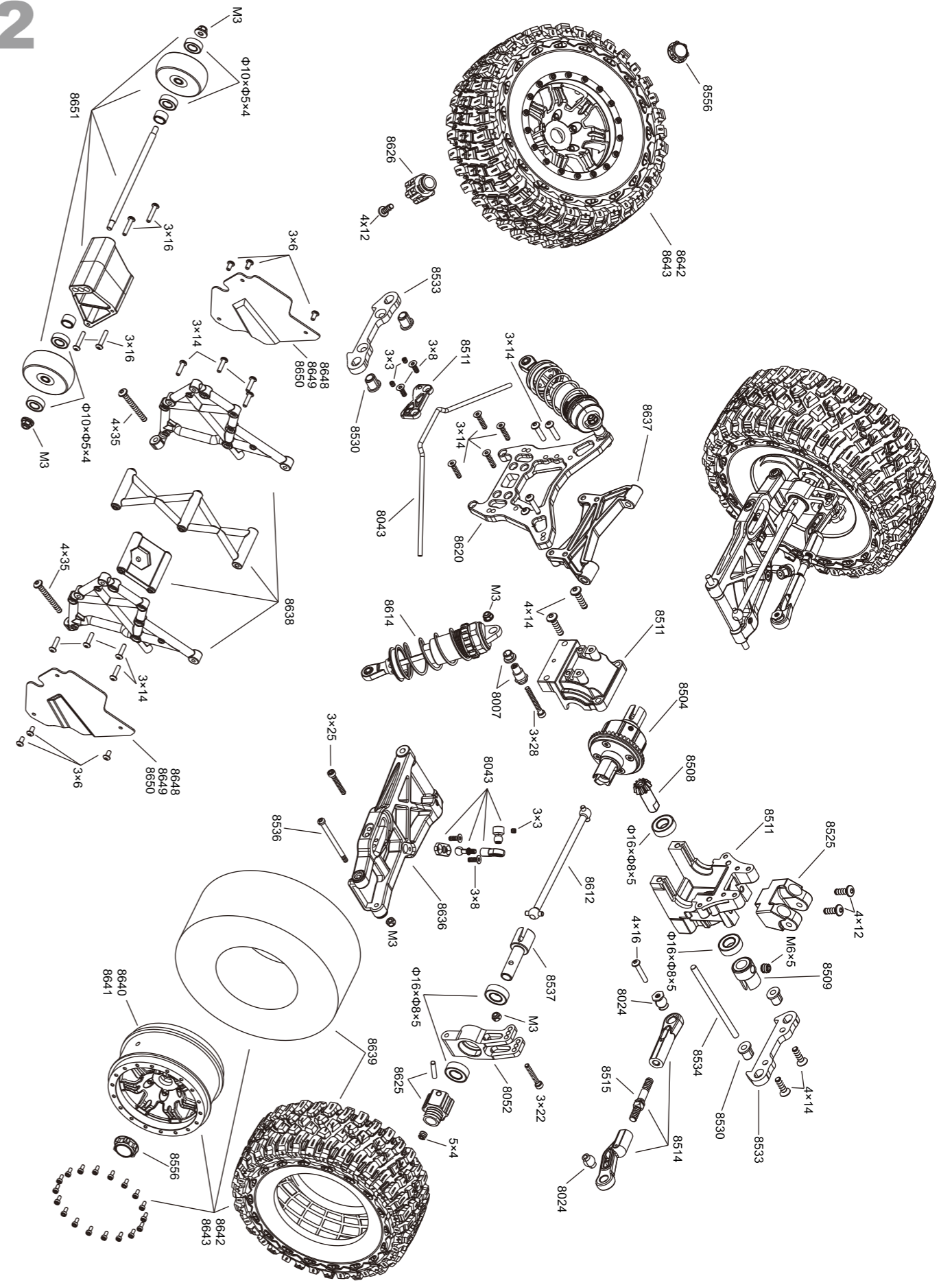

3

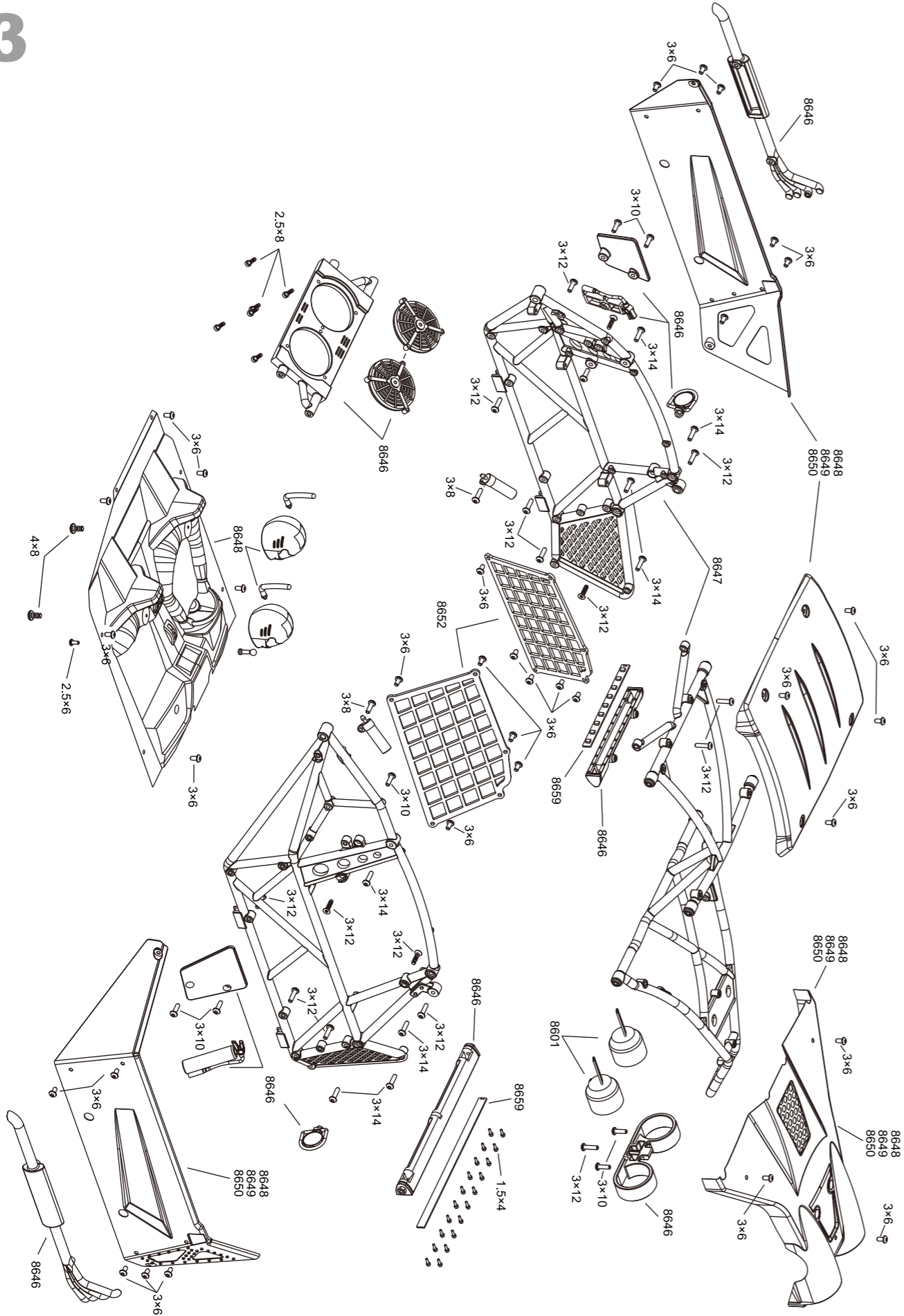

4

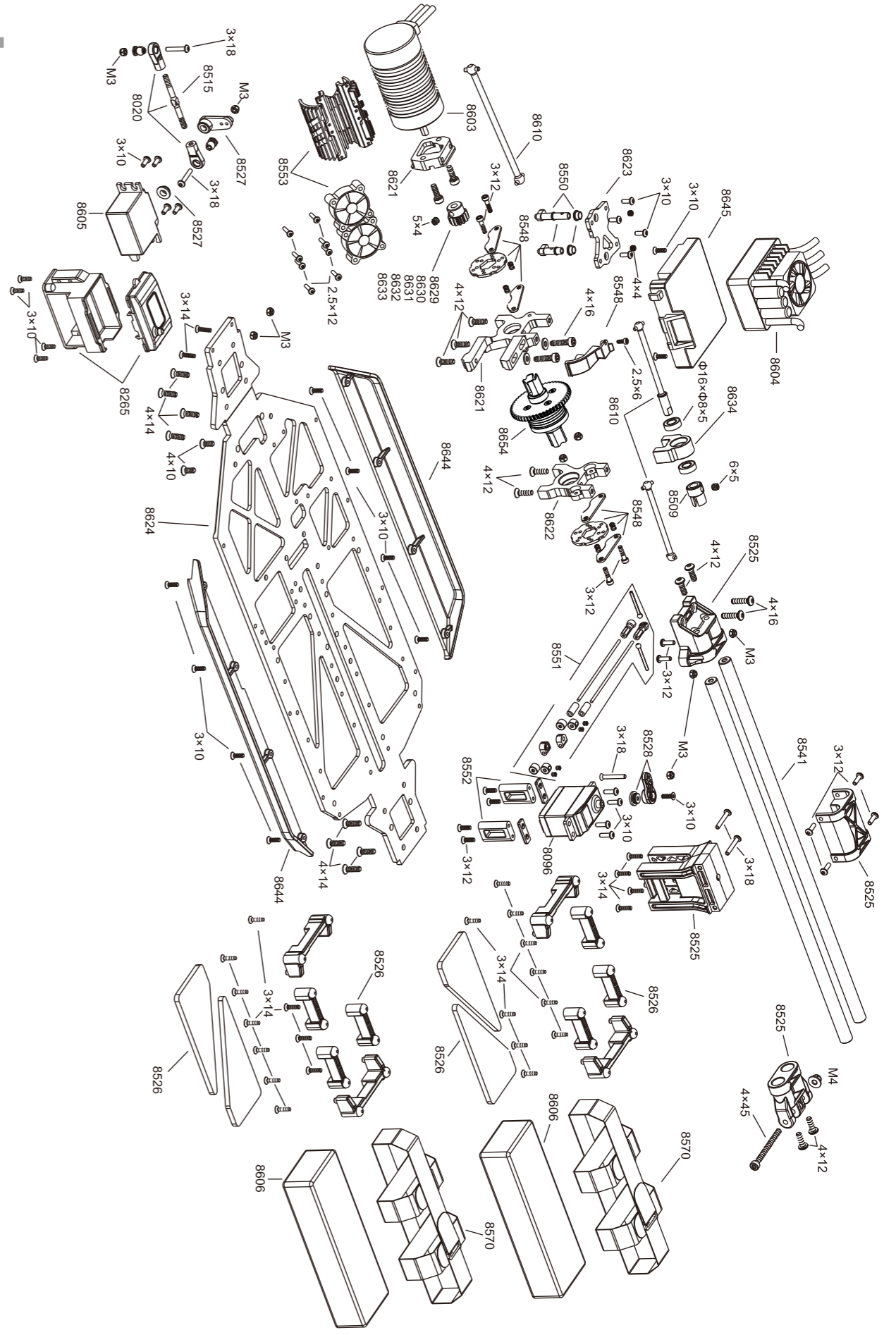

5

F/R Differential(CNC)

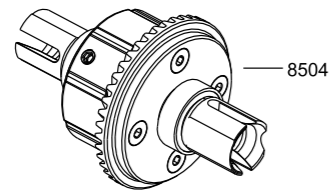

Center Differential(CNC)

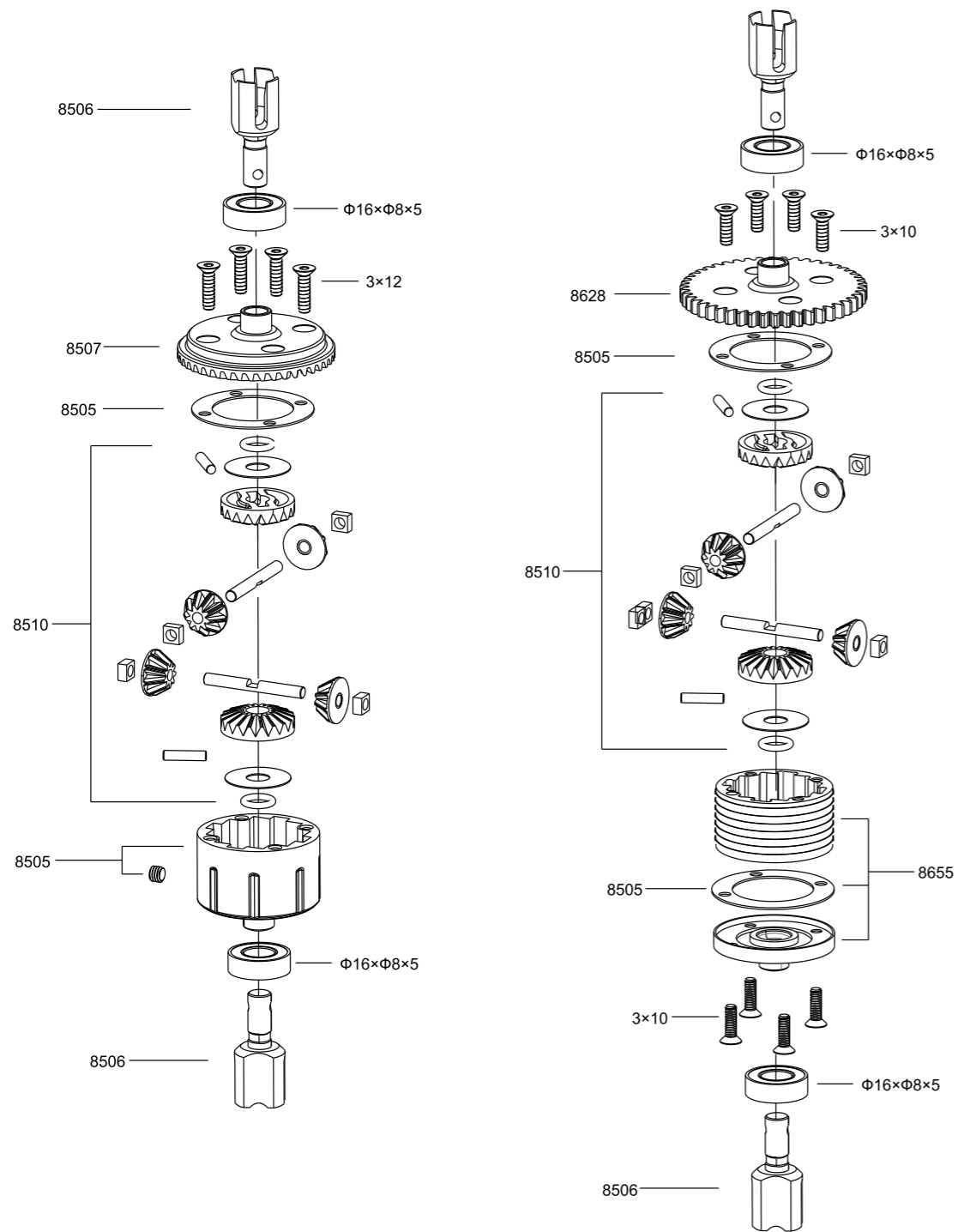
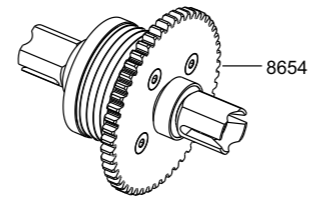



GENERAL REPLACEMENT PARTS

<p>8504</p> <p>F/R Differential(CNC)</p>	<p>8505</p> <p>Differential Case</p>	<p>8506</p> <p>Planet Gear Joints</p>	<p>8507</p> <p>43T F/R Ring Gear(CNC)</p>
<p>8508</p> <p>11T Pinion Gear (CNC)</p>	<p>8509</p> <p>Drive CUPS</p>	<p>8510</p> <p>Differential bevel gear</p>	<p>8511</p> <p>Gear Box</p>
<p>8512</p> <p>Front Upper Suspension</p>	<p>8020</p> <p>Steering Rods I</p>	<p>8513</p> <p>Steering Rods II</p>	<p>8514</p> <p>Rear Upper Tie Rod</p>
<p>8515</p> <p>All Rods</p>	<p>8024</p> <p>All Ball Heads</p>		
<p>8516</p> <p>Steering Plate</p>	<p>8028</p> <p>Steering</p>	<p>8032</p> <p>Steering Shafts</p>	<p>8517</p> <p>C Mounts</p>
<p>8007</p> <p>Shock Absorber Bushing</p>	<p>8043</p> <p>Anti-roll Bar</p>	<p>8525</p> <p>Support shaft bracket</p>	<p>8265</p> <p>Receiver box</p>

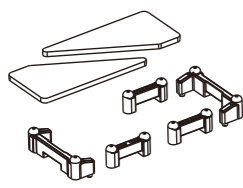
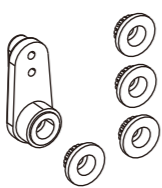
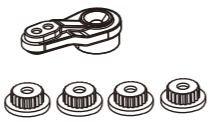
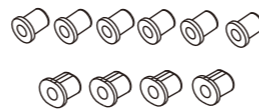
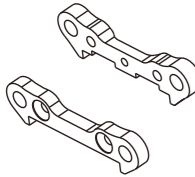
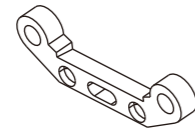
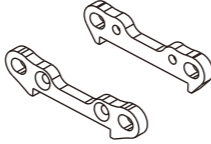
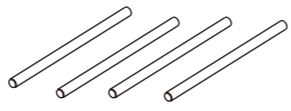
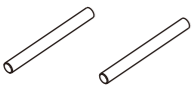
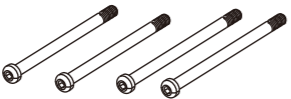
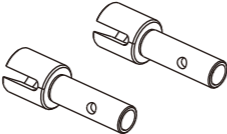
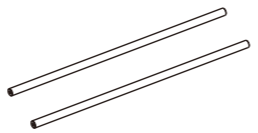
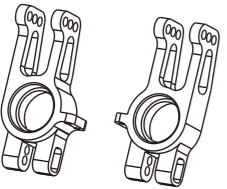
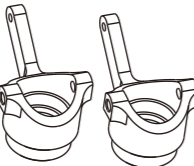
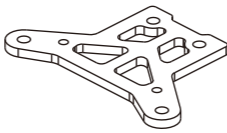
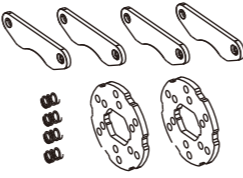
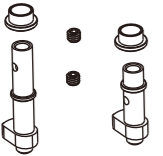
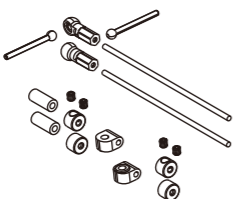
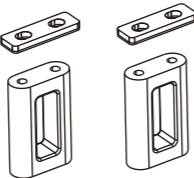
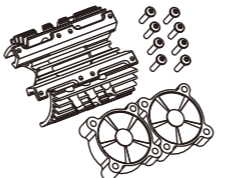
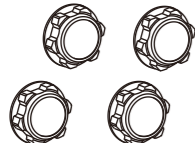
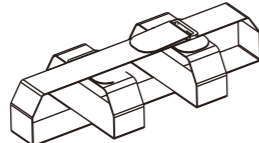
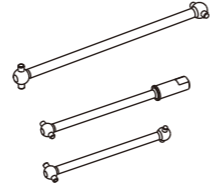
GENERAL REPLACEMENT PARTS

8526  Battery mount	8527  Servo Horns	8528  Servo Horns	8530  Bush Adjuster
8531  Front Suspension Hinge Pin Holder	8532  Front Upper Suspension Hinge Pin Holder	8533  Rear Suspension Hinge Pin Holder	8534  Lower Hinge Pin
8535  Upper Hinge Pin	8536  C-Mount and Rear Hub Carrier Pin	8537  Wheel Axle	8541  Support shaft
8051  Rear Hub(CNC)	8052  Steering Cups(CNC)	8545  Front Upper Plate(CNC)	8548  Brake Disc and Pad Set
8550  Brake Set	8551  Brake Rods and Throttle Rods	8552  Servo Mount	8553  Motor Heatsink Φ40/Φ42
8556  Wheel Nut(CNC)	8570  Magic Tape		8610  Center Drive Shaft

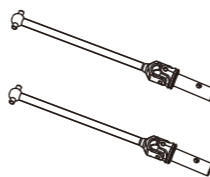
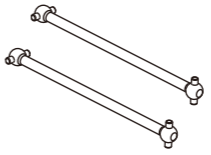
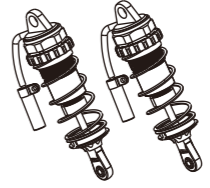
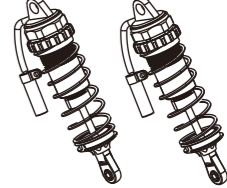
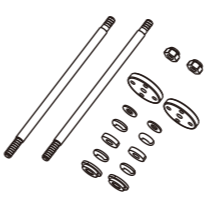
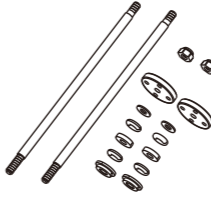
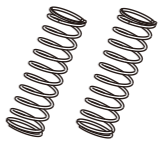
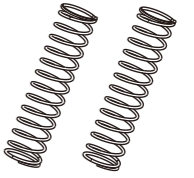
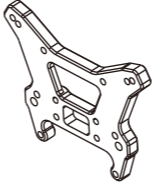
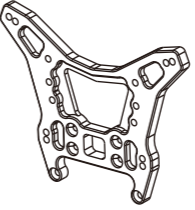
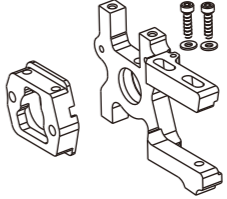
GENERAL REPLACEMENT PARTS

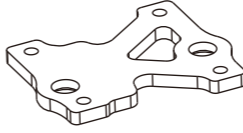
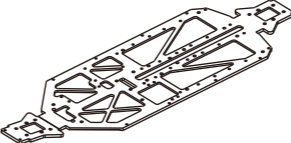
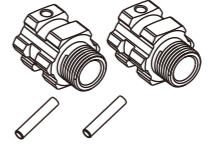
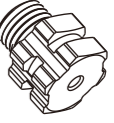
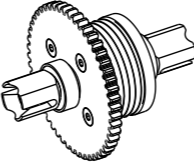
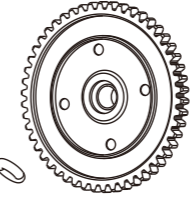
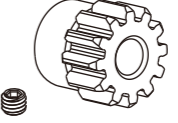
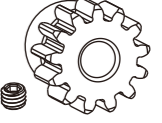
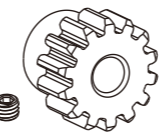
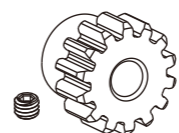
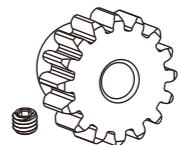
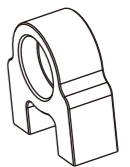
8611  Front CVD	8612  Rear Drive Shaft (106mm)	8613  Front Shock Absorbers	8614  Rear Shock Absorbers
8615  Front Shock Absorber Shafts	8616  Rear Shock Absorber Shafts	8617  Front Shock Absorber Springs	8618  Rear Shock Absorber Springs
8619  Front Shock Tower(CNC)	8620  Rear Shock Tower(CNC)	8621  Motor Mount(CNC)	8622  Center Diff. Mount(CNC)
8623  Center diff. Support Plate(CNC)	8624  Chassis(CNC)	8625  Wheel Hub	8626  Spare Tire Hub
8654  Center Differential Gear Set Aluminium	8628  Center Diff Spur Gear 50T	8629  Motor Gear 12T	8630  Motor Gear 13T
8631  Motor Gear 14T	8632  Motor Gear 15T	8633  Motor Gear 16T	8634  Center Drive Shaft Bearing Mount

GENERAL REPLACEMENT PARTS

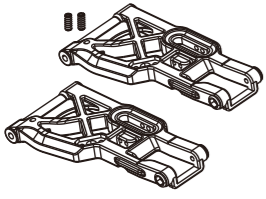
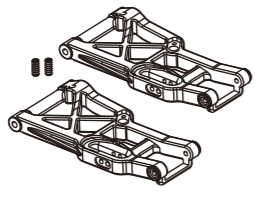
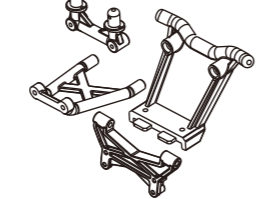
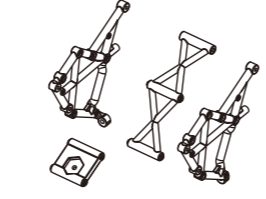
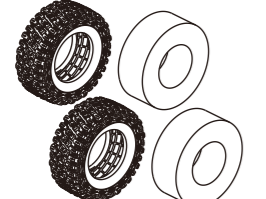
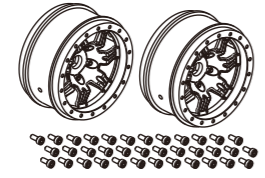
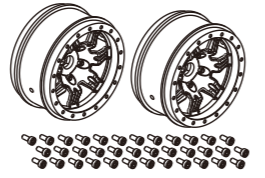
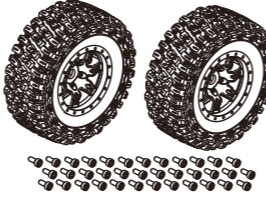
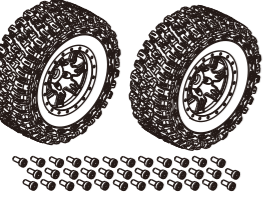
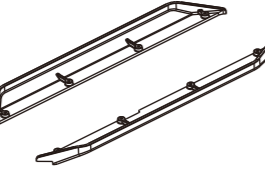
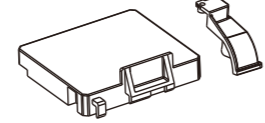
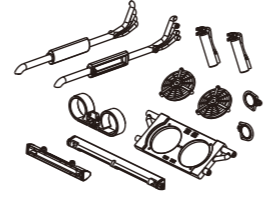
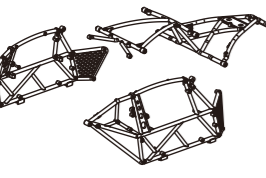
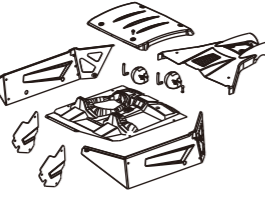
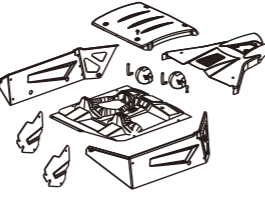
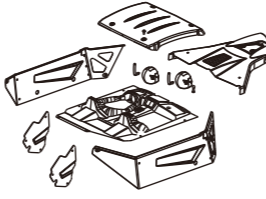
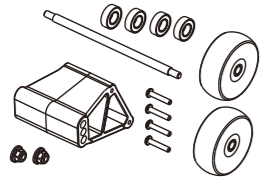
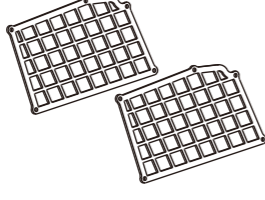
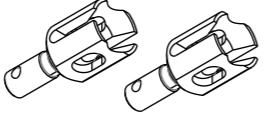
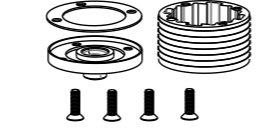
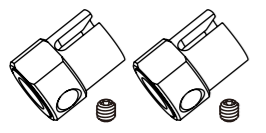
<p>8635</p>  <p>Front Lower Suspension Arm</p>	<p>8636</p>  <p>Rear Lower Suspension Arm</p>	<p>8637</p>  <p>Front Bumper&Body post set</p>	<p>8638</p>  <p>Spare Tire Mount</p>
<p>8639</p>  <p>Tire With Foam Insert</p>	<p>8640</p>  <p>wheel(blue)</p>	<p>8641</p>  <p>wheel (Titanium grey)</p>	<p>8642</p>  <p>Wheel & Tire Set (blue)</p>
<p>8643</p>  <p>Wheel & Tire Set (Titanium grey)</p>	<p>8644</p>  <p>Side Plates</p>	<p>8645</p>  <p>Motor gear cover</p>	<p>8646</p>  <p>To protect the rack accessorise</p>
<p>8647</p>  <p>To Protect the rack</p>	<p>8648</p>  <p>Body(blue)</p>	<p>8649</p>  <p>Body(black)</p>	<p>8650</p>  <p>Clear Body</p>
<p>8651</p>  <p>Look up wheel group</p>	<p>8652</p>  <p>Protective net</p>	<p>8653</p>  <p>Planet Gear Joints S2</p>	<p>8655</p>  <p>Differential Case Aluminium</p>
<p>8656</p>  <p>Drive Cups S2</p>			

GENERAL REPLACEMENT PARTS

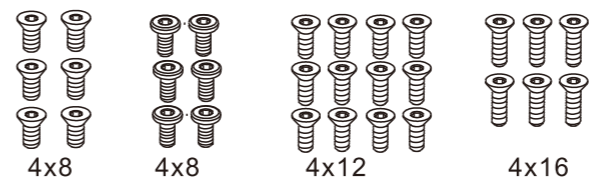
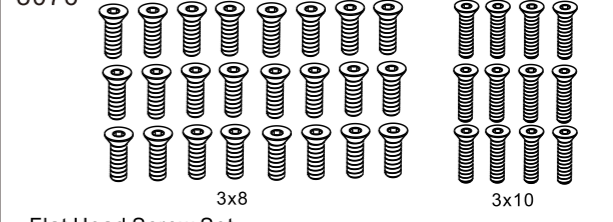
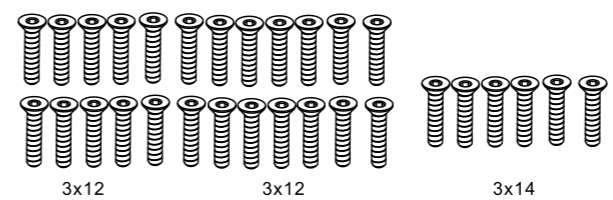
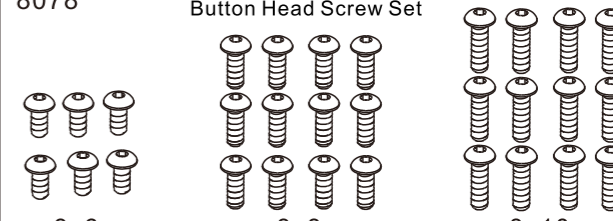
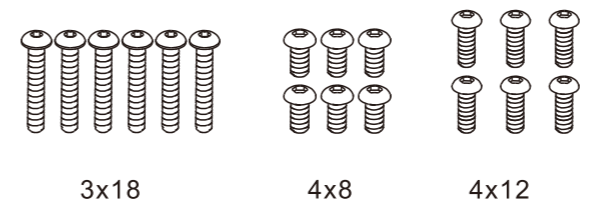
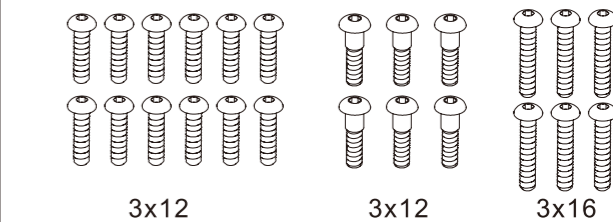
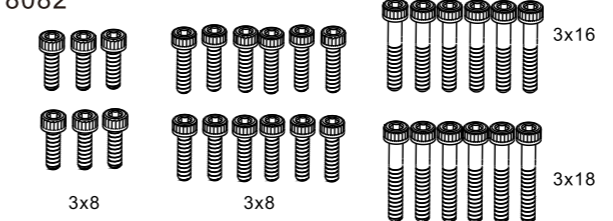
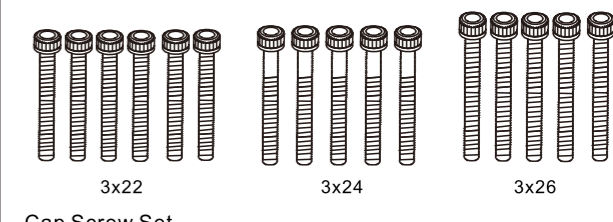
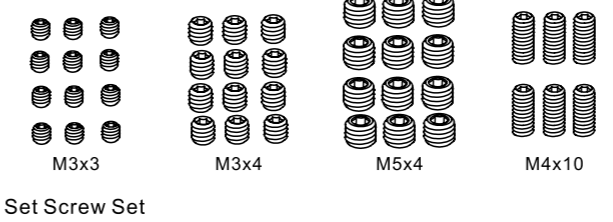
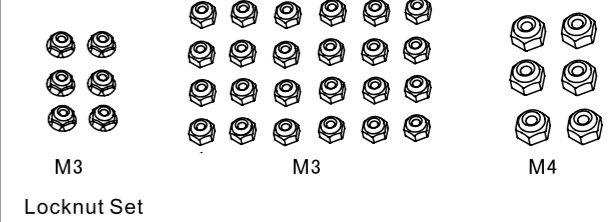
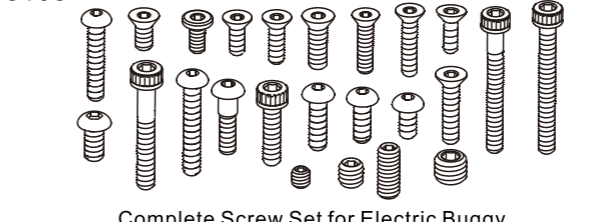
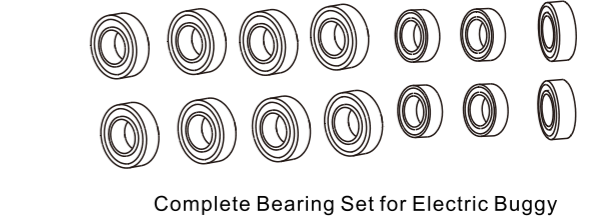
<p>8075</p>  <p>4x8 4x8 4x12 4x16</p> <p>Flat Head & Cap Screw Set</p>	<p>8076</p>  <p>3x8 3x10</p> <p>Flat Head Screw Set</p>
<p>8077</p>  <p>3x12 3x12 3x14</p> <p>Flat Head Screw Set</p>	<p>8078</p>  <p>3x6 3x8 3x10</p> <p>Button Head Screw Set</p>
<p>8079</p>  <p>3x18 4x8 4x12</p> <p>Button Head Screw Set</p>	<p>8081</p>  <p>3x12 3x12 3x16</p> <p>Button Head Screw Set</p>
<p>8082</p>  <p>3x8 3x8 3x16 3x18</p> <p>Cap Screw Set</p>	<p>8083</p>  <p>3x22 3x24 3x26</p> <p>Cap Screw Set</p>
<p>8084</p>  <p>M3x3 M3x4 M5x4 M4x10</p> <p>Set Screw Set</p>	<p>8085</p>  <p>M3 M3 M4</p> <p>Locknut Set</p>
<p>8108</p>  <p>Complete Screw Set for Electric Buggy</p>	<p>8109</p>  <p>Complete Bearing Set for Electric Buggy</p>

GENERAL REPLACEMENT PARTS

8586

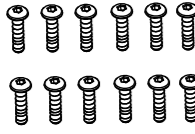

Button Head Screws M4x16

8587

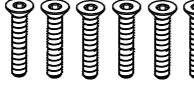

Flat Head Screws M4x30

8588

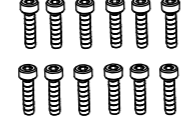

Cap Screws M4x16

8589



Cap Screws M4x35

8590



Cap Screws M4x45

8591



Cap Screws M6x5

8593



Servo Mount(CNC)

8594



Steering(CNC)

8601



Headlight

8602S

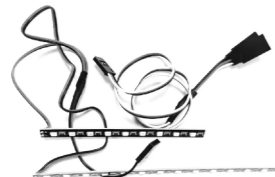

Tail lights

8603



4282 Brushless Motor 2000KV

8604



150A Brushless ESC

8096



9KG Servo

8605



15KG Servo

7594



2.4G Radio set + Receiver

7595



2.4G Radio set

7596



Receiver

8606



11.1V 35C 5000MAH

6215



B3 Li-Po Charger

