

1/7 Scale 4WD ELECTRIC MONSTER TRUCK

Manual

www.zdhobby.com

MX-07



This manual expatiates the structure of the model. In order to better maintain and replace the spare parts, please keep and take it for reference. The user who is not familiar with the assembling, please contact with the wholesaler, nominated model shops and the Special after-sale service outlets.

The actual version is subject to the real standard. It would be varied because of different versions.

ZD RACING



[WWW.ZDHOBBY.COM](http://www.zdhobby.com)

ZD RACING

www.zdhobby.com



Made in china

The spare parts, appearance of this model will be tiny revised and changed before totally upgrade into a new version, ZD reserve this rights, and no further notice.

INTRODUCE

Thank you for choosing the ZD racing series products. Our company take the target of offering the top quality and best service. Through attending the competitions and repeated testing the products, constantly enhancing our experience, then further improving the design and quality control. Only for showing the great performance products. This manual including all the important matter before operating the car. We advise studying and knowing the control system before assembling or playing it. As well as the further upgrade and maintenance. Please feel free to consult our authorized dealer, nominated model shop or special after-sale service station if any question refer to the play or use. Our website is: www.zdhobby.com. We are wholeheartedly for your service.

QUALITY ASSURANCE

Our company take the fully responsibility to the quality defect during the manufacturing process. This assurance is only subject to the product only and its spare parts.

These situation below are not included:

- The breakage caused by using, assembling or adjustment.
- The other breakage not related to the quality itself.

IMPORTANT STATEMENT

The Model Car is not a toy. It is the casual item combine a lot of high technology products. If using improper may bring serious damage. Please read the manual detailed before using, and keep yourself safe.

Attention: Any operation of the Model car, the manufacturer and dealers are incapable of take the responsibility of the accidents caused by wear out or abnormal assemble.

This product is provided to those who have operation remote control model car experience or a technical personnel in the guidance of the local legal field, in has to ensure the safe and correct operation under the condition of use. Our company will not accept any operation and use the control on any performance and safety responsibility

The RC products are belong to consumable goods, if disassemble, it may cause the spare parts loss, Any use of goods caused by bad or not satisfied, will not be able to replace or return, such as in case of operation maintenance problems, the company designated national distributor model shop and special after-sale service store will provide technical guidance, and special parts supply services.



Warning: because of the neglect of these operating instructions, and use wrongly may cause property damage or serious injury.

Note: because of the neglect of these operating instructions, and use wrongly could be dangerous.

Ban: in any prohibited environment, do not try to operation.

SAFETY GUIDELINES

1. Don't operation the models close to open fires or near heat source.
2. Operation must be in the open and dry site .
3. The thunderstorm weather is forbidden to operate this product.
4. Away from the high voltage cables.
5. Some of the parts will be exothermic or burning after operated.
6. Please do not use hand or foreign body contact activities of the parts before cut off the power supply,

7. During the operation, if foreign matter or liquid get into eyes, please timely with plenty of water flush eyes, and immediately consulting professional doctor. As the body is injured, please seek immediate medical attention.
8. Keep out of the reach of children, this is not toy, strongly suggest adult supervision.
9. Placed in ventilated and dry place, do not use, take the battery out.
10. The product items do not diet or swallowed.

2.4G RC WITH 4-CHANNELS SETUP AND FAIL SAFE FUNCTION

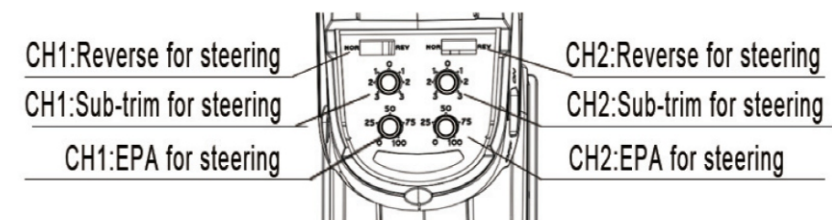
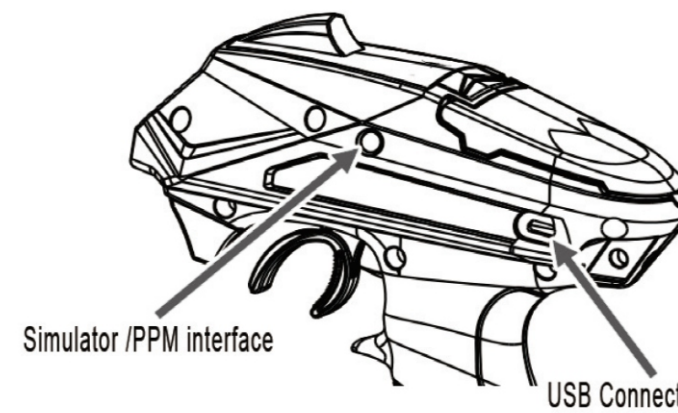
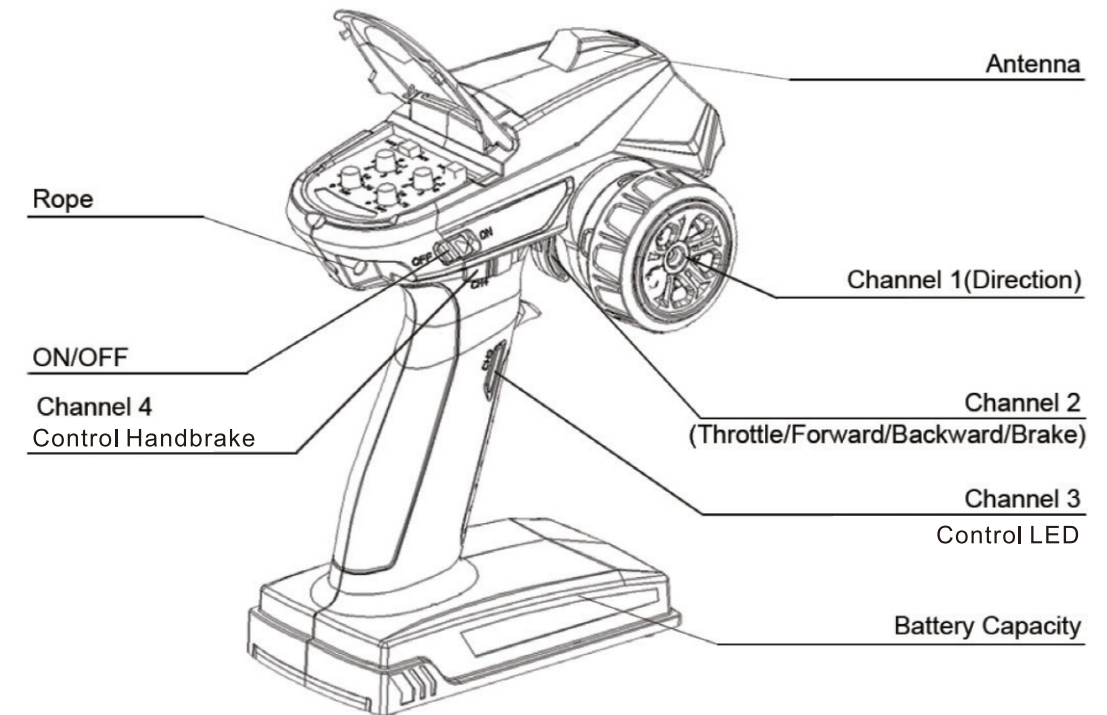

Receiver

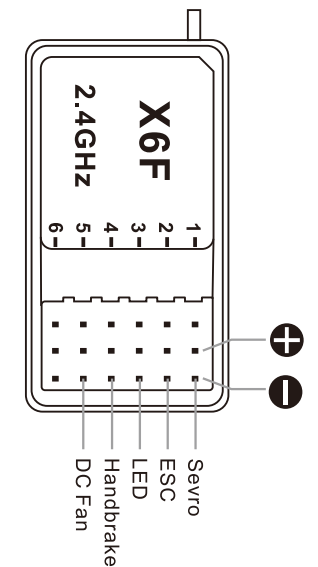

CHARGING THE BATTERY PACK

- A. Once the battery ready to be charged, first plug the AC quick charger into the outlet of AC power source, and then connect the battery input/output harness to the charger.
- B. Continued to monitor the battery as it is being charged. As soon as the battery is fully charged, disconnect the battery from the charger plug (Over-charging or charging incorrectly using inadequate chargers may cause the battery pack to become dangerously hot).
- C. For best results, let the battery pack cool before charging. Heat may prevent the battery pack from charging to full capacity and also decreases the performance of the battery.

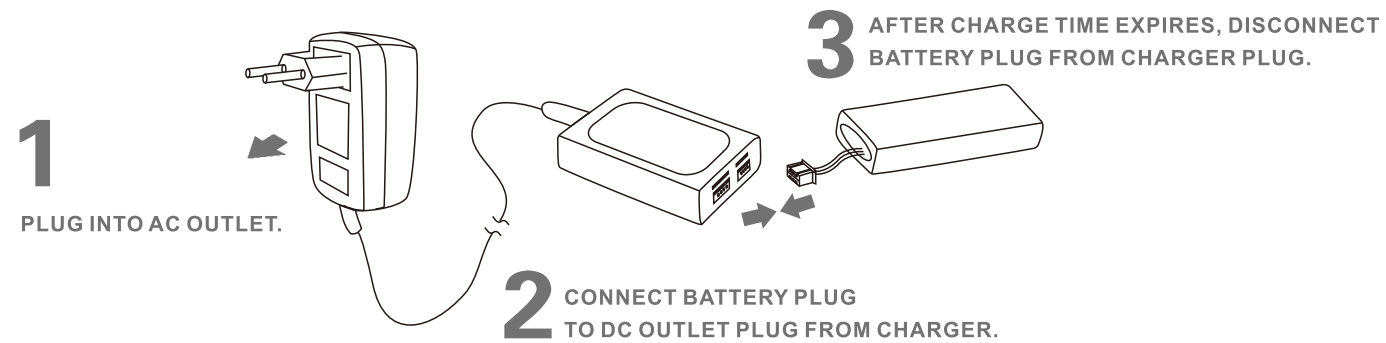

BATTERIES

Lithium Polymer (Li-Po) batteries are becoming popular for use in R/C models due to their compact size, high energy density, and high-current output. However, these types of batteries require special care and handling procedures for long life and safe operation.

Warning: Lithium Polymer (Li-Po) batteries are intended only for advanced users that are educated on the risks associated with Li-Po battery use. THUNDER TIGER/ACE RC does not recommend that anyone under the age of 16 use or handle Li-Po battery packs without the supervision of a knowledgeable and responsible adult.

- Important:**
1. Do not use NiCd/Ni-MH battery chargers for Li-PO batteries. If you do not use a special charger for Li-PO battery, they will be damaged.
 2. If the battery is swollen or damaged, it is forbidden to use.
 3. Do not charge for long periods when left unattended.

Please note! Consumers for use or installation of lipo battery in the remote control model belongs and cause any Direct or indirect damages, our company will not bear any legal liability.

Steering operation guide

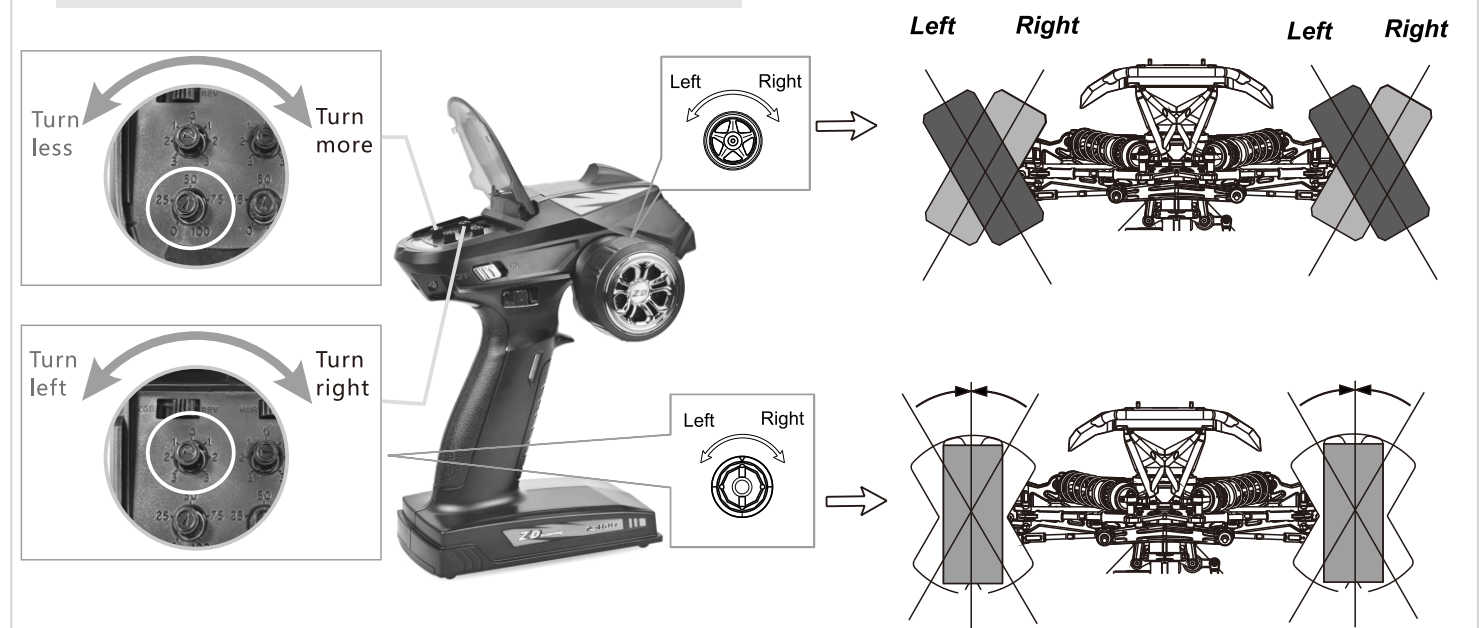

- 1) slowly rotating around the steering wheel, the car will be slow to the right or to the left accordingly (when there is no consistent please toggle on the remote control ST direction and rudder switch).
- 2) when the cars can't run straight, you can adjust to direction of the remote control on the median knob, until the vehicle can run straight.

- ◆ Adjust the Median trimming to keep the front wheel in the center position
- ◆ When testing the diversion of the car, please keep the front wheel hang in the air.

Racing Steps

1. Turn on the remote control switch, the power indicator flashes.
2. Turn the steering wheel and throttle trigger, everything is normal, you can go running.
3. Finish racing, Turn off the ESC and off the radio, disconnect the power plug.

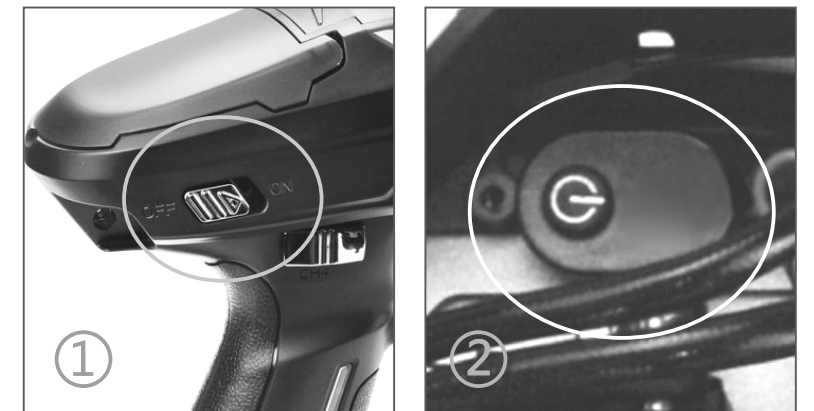

3

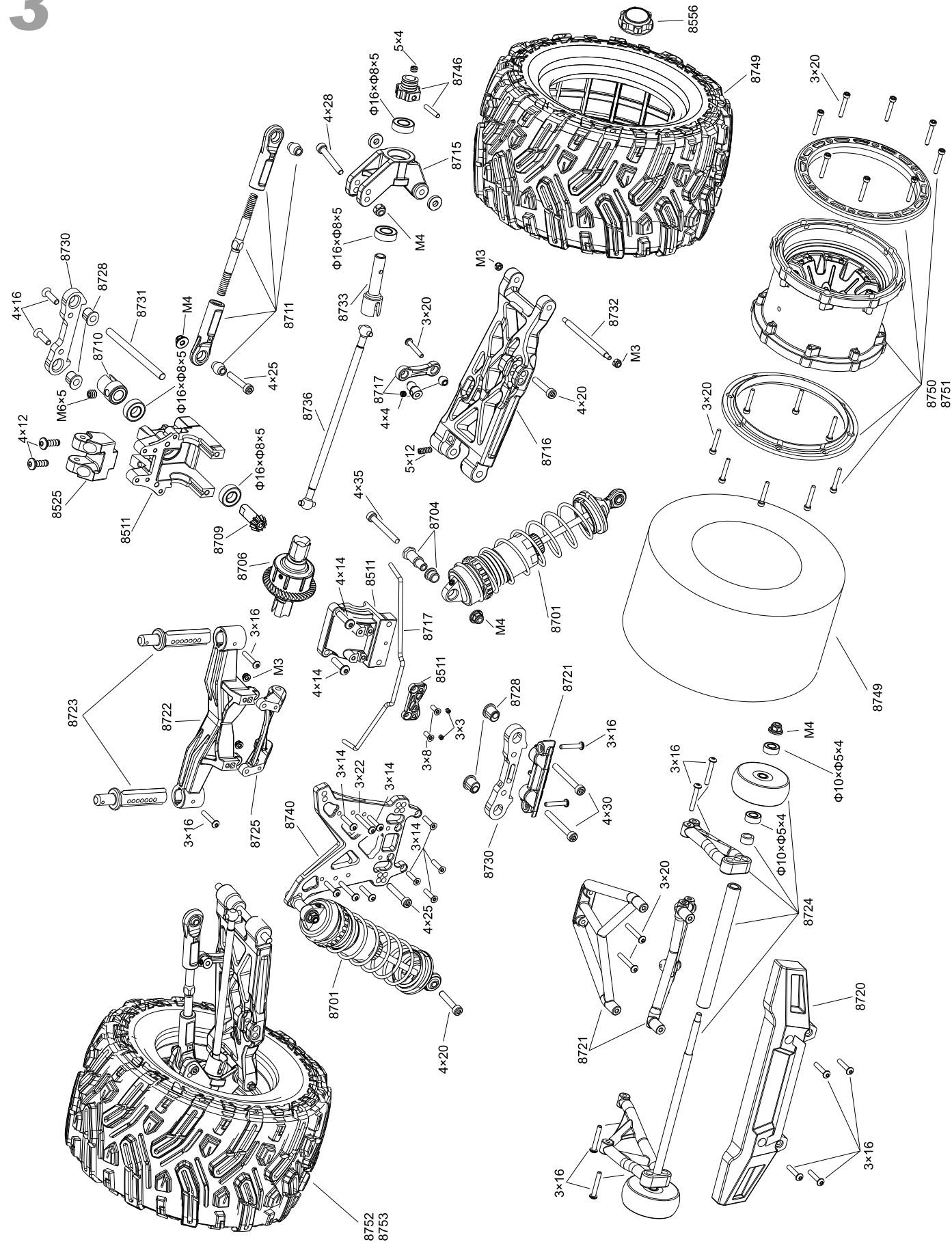

4

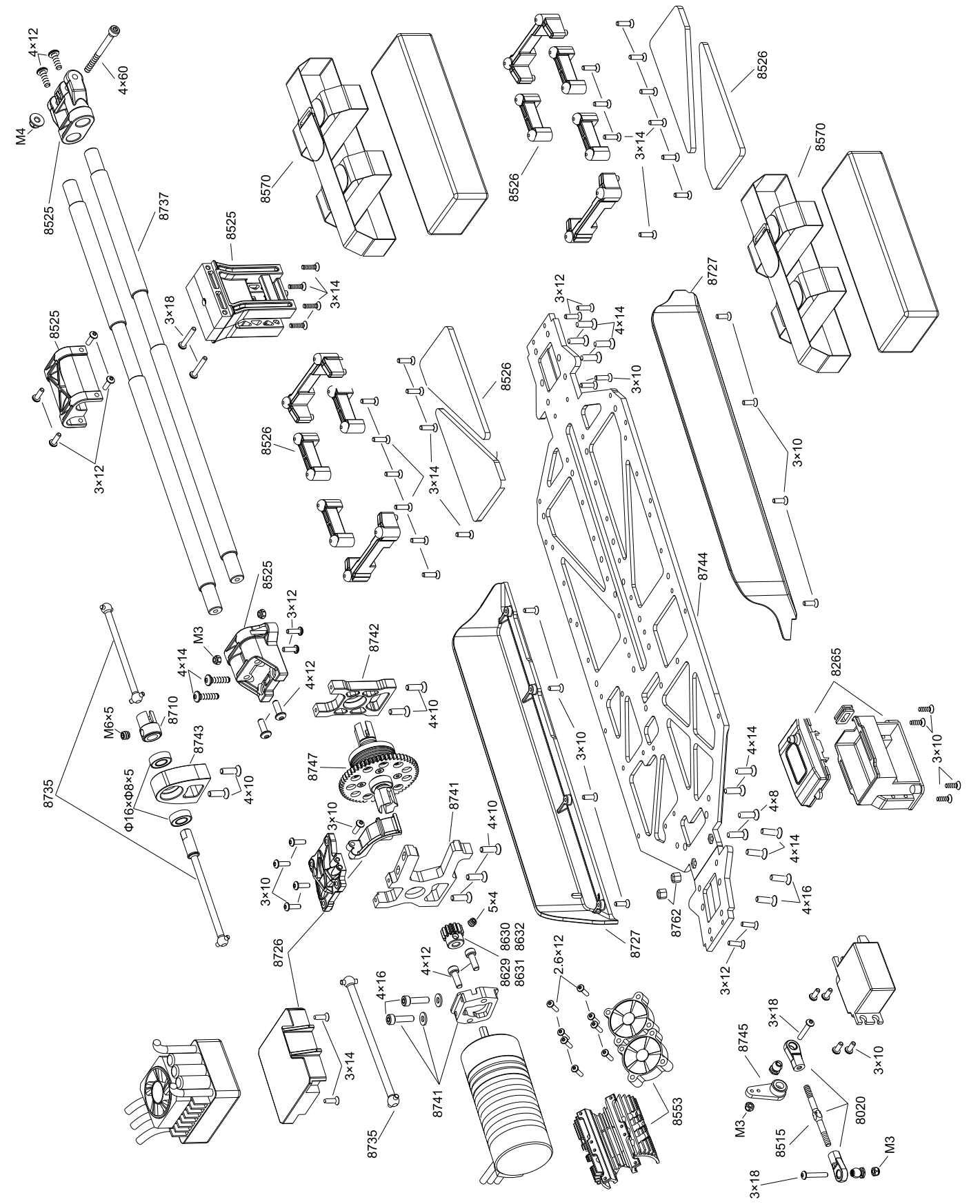

5

F/R Differential(CNC)

Center Differential(CNC)

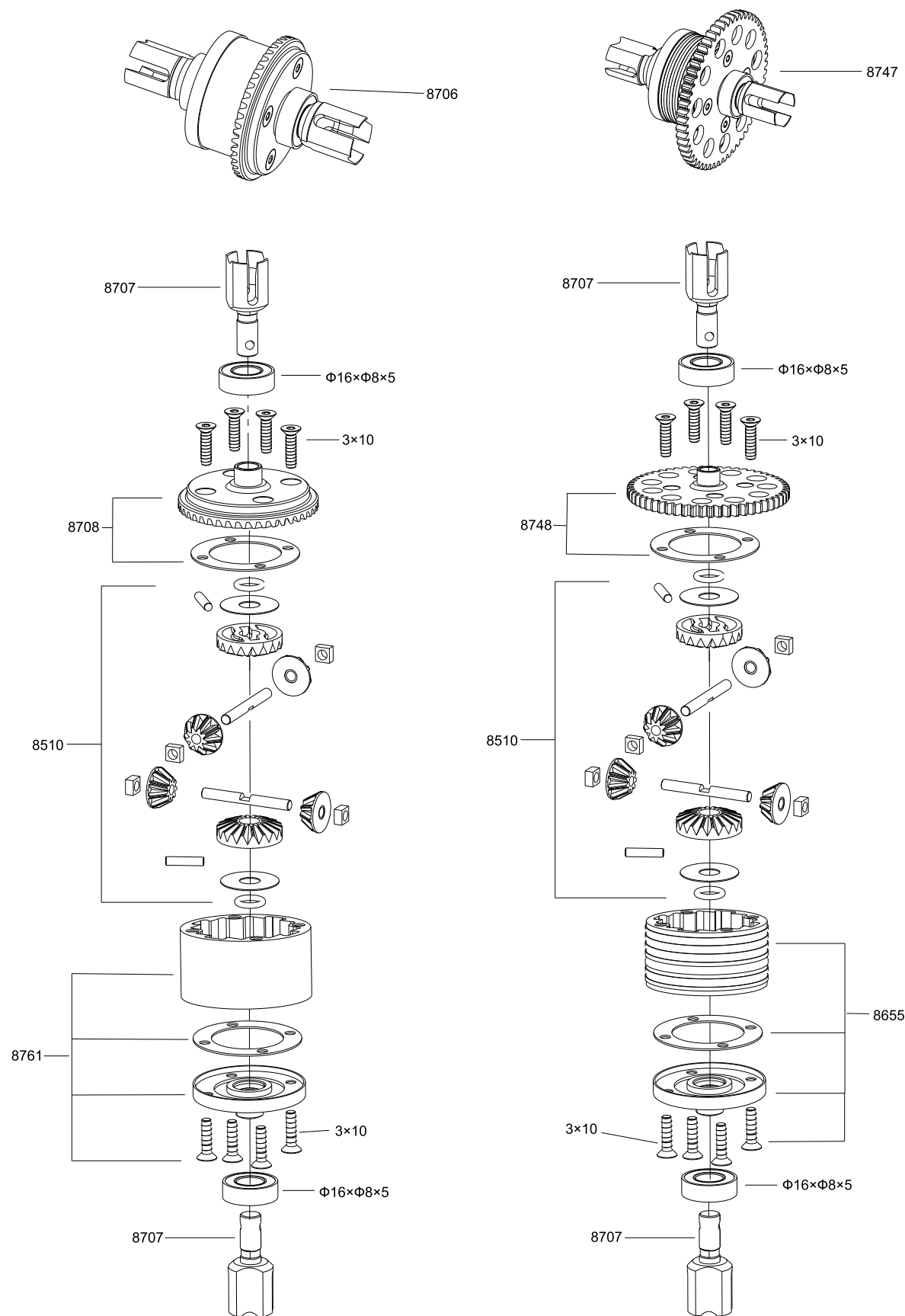





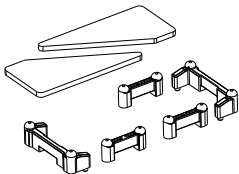
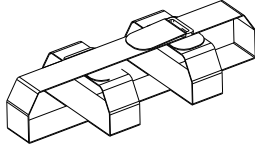
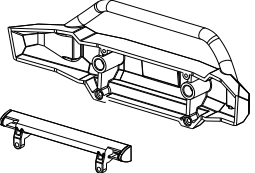
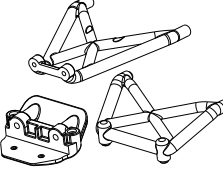
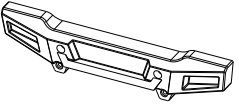
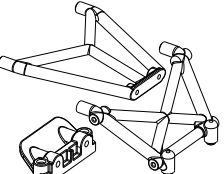
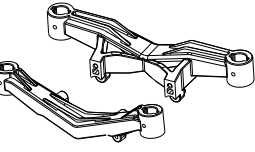
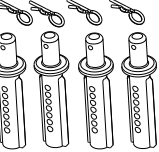
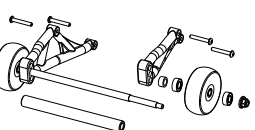
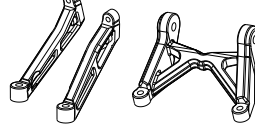
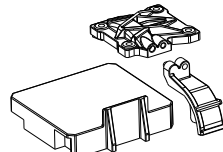
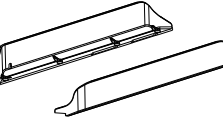
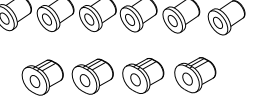
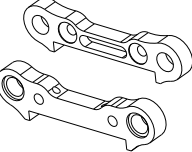
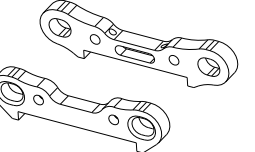
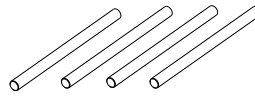
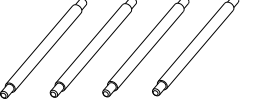
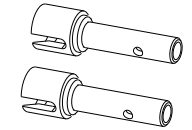
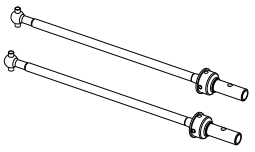
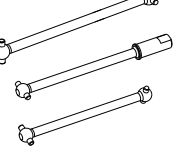
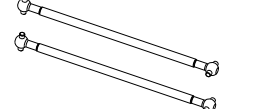
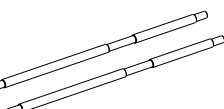
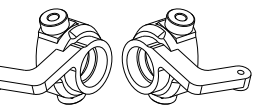
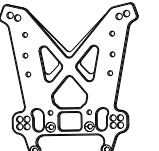

GENERAL REPLACEMENT PARTS

<p>8701</p> <p>Shock Absorbers</p>	<p>8702</p> <p>Shock Absorbers Springs</p>	<p>8703</p> <p>Shock Absorber Shafts</p>	<p>8704</p> <p>Shock Absorber Bushing</p>
<p>8705</p> <p>Shock Absorbers Dirt-Proof Boots</p>	<p>8510</p> <p>Differential bevel gear</p>	<p>8511</p> <p>Gear Box</p>	<p>8706</p> <p>F/R Differential(CNC)</p>
<p>8707</p> <p>Planet Gear Joints</p>	<p>8708</p> <p>43T F/R Ring Gear(CNC)</p>	<p>8709</p> <p>11T Pion Gear (CNC)</p>	<p>8710</p> <p>Drive CUPS</p>
<p>8711</p> <p>F/R Upper Tie Rods</p>	<p>8712</p> <p>Steering Rods II</p>	<p>8020</p> <p>Steering Rods I</p>	<p>8516</p> <p>Steering Plate</p>
<p>8713</p> <p>Steering</p>	<p>8032</p> <p>Steering Shafts</p>	<p>8714</p> <p>C Mounts</p>	<p>8715</p> <p>Rear Hub</p>
<p>8716</p> <p>F/R Lower Suspension Arm</p>	<p>8717</p> <p>Anti-roll Bar</p>	<p>8525</p> <p>Support shaft bracket</p>	<p>8265</p> <p>Receiver box</p>

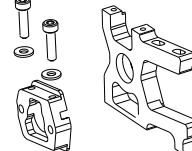
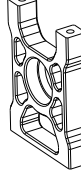
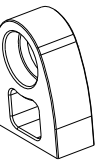
GENERAL REPLACEMENT PARTS

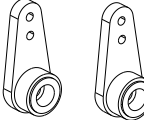
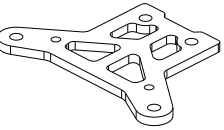
8526  Battery mount	8570  Magic Tape	8718  Front Bumper	8719  Front Bumper Bracket
8720  Rear Bumper	8721  Rear Bumper Bracket	8722  F/R Body Mount Bracket	8723  Body Mount
8724  Look up wheel group	8725  Shock Tower Reinforcing block	8726  Motor gear cover	8727  Side Plates
8728  Bush Adjuster	8729  Front Suspension Hinge Pin Holder	8730  Rear Suspension Hinge Pin Holder	8731  Lower Hinge Pin
8732  C-Mount and Rear Hub Carrier Pin	8733  Wheel Axle	8734  Front CVD	8735  Center Drive Shaft
8736  Rear Drive Shaft (145.3mm)	8737  Support shaft	8738  Steering Cups(CNC)	8739  Front Shock Tower(CNC)

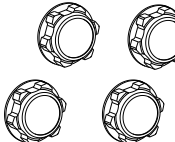
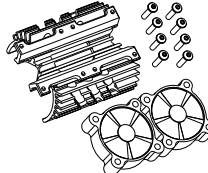
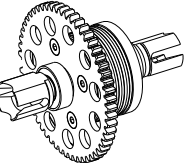
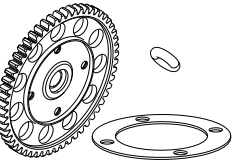
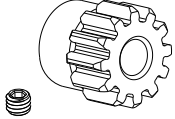
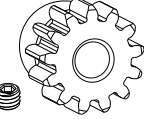
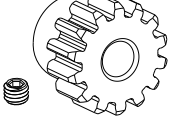
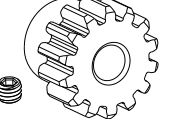
GENERAL REPLACEMENT PARTS

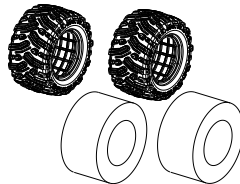
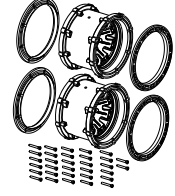
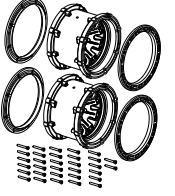
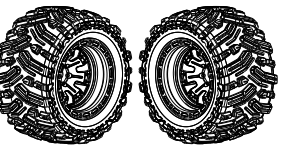
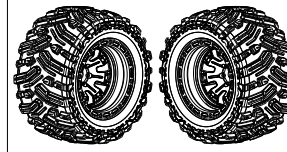
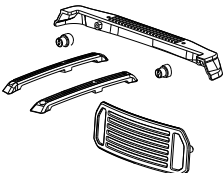
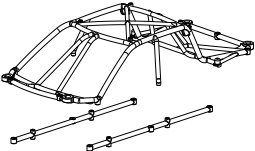
8740  Rear Shock Tower(CNC)	8741  Rear Shock Tower(CNC)	8742  Center Diff. Mount(CNC)	8743  Center Drive Shaft Bearing Mount
8744  Chassis 7075(CNC)	8745  Servo Horns	8545  Front UpperPlate(CNC)	8746  Wheel Hub
8556  Wheel Nut(CNC)	8553  Motor Heatsink Φ40/Φ42	8747  Center Differential Gear Set	8748  Center Diff Spur Gear 55T
8629  Motor Gear 12T	8630  Motor Gear 13T	8631  Motor Gear 14T	8632  Motor Gear 15T
8762  Suspension Holder Reinforcing block	8749  Tire With Foam Insert	8750  Wheel(Black)	8751  Wheel(Silver)
8752  Wheel & Tire Set (Black)	8753  Wheel & Tire Set (Silver)	8754  To Protect the rack accessories	8755  To Protect the rack

GENERAL REPLACEMENT PARTS

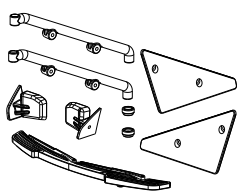
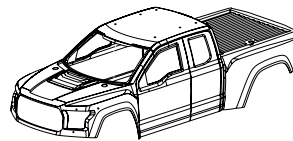
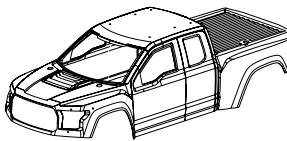
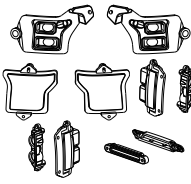
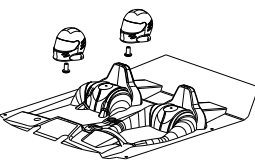
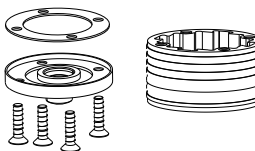
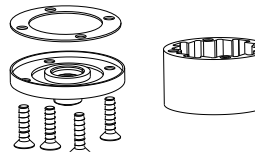
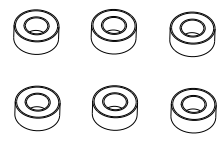
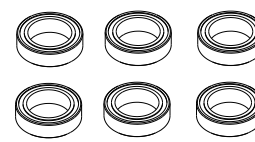
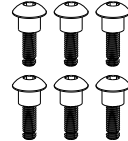
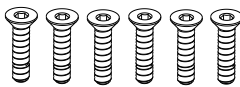
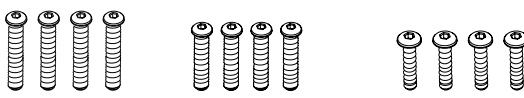
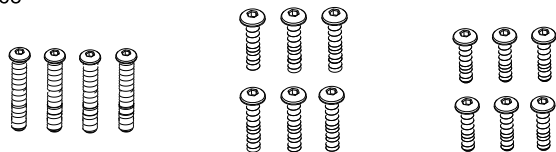
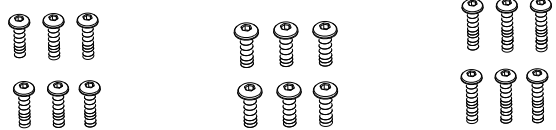
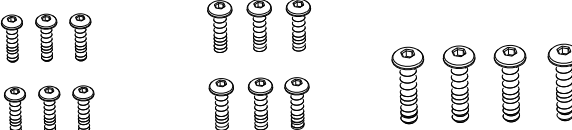
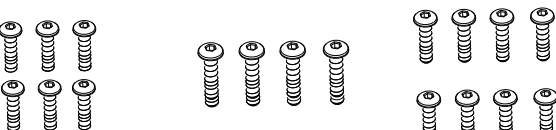
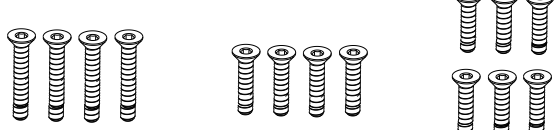
<p>8756</p>  <p>To Protect the rack accessories</p>	<p>8757</p>  <p>Car Body(Silver)</p>	<p>8758</p>  <p>Car Body</p>	<p>8759</p>  <p>Light holderSet</p>
<p>8760</p>  <p>Cockpit</p>	<p>8655</p>  <p>Differential Case Aluminium</p>	<p>8761</p>  <p>Differential Case Aluminium</p>	
<p>8763</p>  <p>Ball bearing $\Phi 16 \times \Phi 8 \times 5$</p>	<p>8764</p>  <p>Ball bearing $\Phi 24 \times \Phi 15 \times 5$</p>	<p>8765</p>  <p>M3x13 Screw rod</p>	<p>8766</p>  <p>Flat Head Screws M4x\H0.99999x;10</p>
<p>8767</p>  <p>3x20 3x18 3x16</p> <p>Button Head Screws Set</p>	<p>8768</p>  <p>3x22 3x14 3x12</p> <p>Button Head Screws Set</p>		
<p>8769</p>  <p>2.5x8 3x6 2.6x12</p> <p>Button Head Screws Set</p>	<p>8770</p>  <p>3x8 4x8 5x16</p> <p>Button Head Screws Set</p>		
<p>8771</p>  <p>3x10 4x14 4x12</p> <p>Button Head Screws Set</p>	<p>8772</p>  <p>3x20 3x14 3x12</p> <p>Flat Head Screws Set</p>		

GENERAL REPLACEMENT PARTS

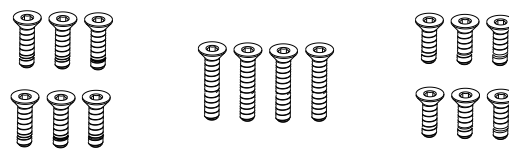
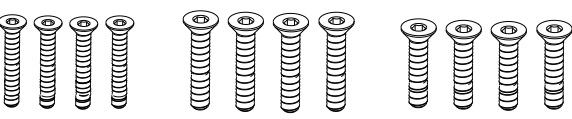
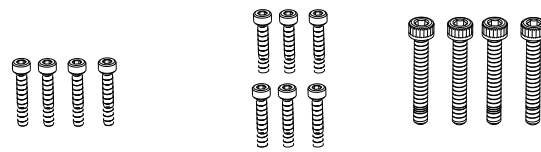
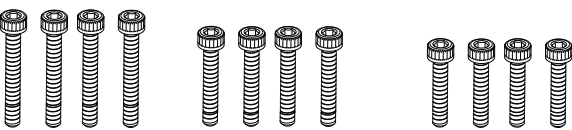
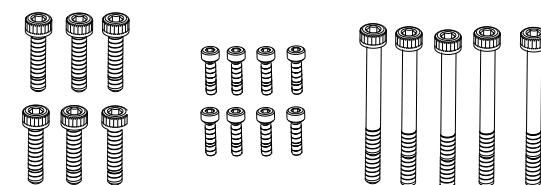
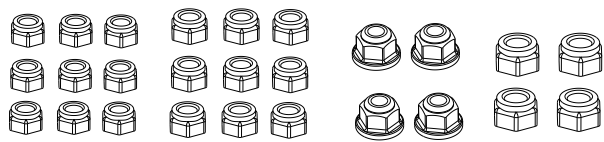
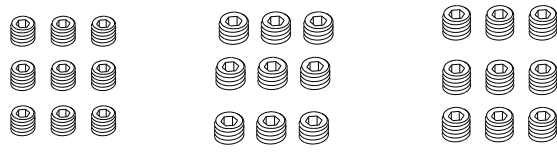
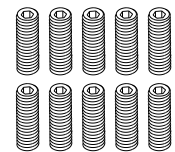
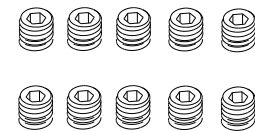
<p>8773</p>  <p>3x10 3x16 3x8</p> <p>Flat Head Screws Set</p>	<p>8774</p>  <p>3x18 4x16 4x14</p> <p>Flat Head Screws Set</p>		
<p>8775</p>  <p>3x20 3x18 4x25</p> <p>Cap Screws Set</p>	<p>8776</p>  <p>4x28 4x20 4x16</p> <p>Cap Screws Set</p>		
<p>8777</p>  <p>4x12 2.5x8 4x60</p> <p>Cap Screws Set</p>	<p>8778</p>  <p>M2.5 M3 M4 M4</p> <p>Locknut Set</p>		
<p>8779</p>  <p>M3x3 M4x4 M5x4</p> <p>Set Screws Set</p>	<p>8780</p>  <p>Set Screw M5x12</p>	<p>8781</p>  <p>Set Screw M6x5</p>	

GENERAL REPLACEMENT PARTS

8786



Tail lights

8787



Lamp group controller

8788



4092 KV1450 Brushless motor

8789



150A Brushless ESC

8790



35KG aluminum frame SERVO

8791



2.4G Radio set + Receiver

7595



2.4G Radio set

8793



Receiver

8606



11.1V 35C 5000MAH

6215



B3 Li-Po Charger

